



Chimney Lining Systems & Direct Vent



Z-FLEX® Aluminum Liner Kits and Connectors

Aluminum Chimney Gas Liner Kits GAS APPLICATIONS

Z-FLEX® Aluminum Chimney Liner Kits come complete with everything needed to quickly and easily install a professional venting system.

Z-FLEX® liner is manufactured using a dead soft aluminum strip which is spirally wound and mechanically joined together forming an air-tight and leakproof Triple Lock™ seam.

Z-FLEX®'s specially designed corrugations provide excellent flexibility while maintaining superior crush strength. The result is a clearly superior product offering incredible longevity.





Aluminum Liner Kit Includes:
 2-Ply Aluminum Liner
 Chimney Flashing
 Rain Cap
 Mortar Collar
 3 Screws
 Part No.: 2GACKIT
 Dia.: ____ | Lgth.: ____
 Dia.: 3", 4", 5", 6", 7", 8", 10"
 Lengths: 15' - 50'

- Patented Triple Lock® design for strength
- Right sized packaging to lower shipping costs
- Best available materials/alloys
- 40+ years of manufacturing experience
- "Immediate" availability (24-72 hour lead time)
- Listed by Underwriters Laboratories

Gas Fireplace Kit Includes:
 2-Ply Aluminum Liner
 Chimney Flashing
 Rain Cap
 Fireplace Adapter (Single Appliance)
 3 Screws
 Part No.: 2GAFKXX
 Dia.: ____ | Lgth.: ____
 Dia.: 3", 4", 5", 6", 7", 8", 10"
 Lengths: 15' - 50'



Z-FLEX® Chimney Liner Systems

Z-FLEX Insul-liner®

Pre-Insulated Chimney Liner for Category 1 Natural Draft Gas Heating Equipment & Gas Fireplaces

- **Insul-Liner®** is another “simple solution” from **Z-FLEX®**. The National Fuel Gas Code (NFPA 54, ANSI Z223.1) recommends that liners be insulated in certain situations.
- A good rule of thumb is to use an insulated liner in exterior chimneys or when a brick chimney has no clay liner at all. The insulation will keep the flue gases warm to prevent condensation. Also refer to the equipment manufacturer’s instructions for their recommendations.
- **Insul-Liner®** replaces B-Vent when relining a masonry chimney.
- **Insul-Liner®** is insulated at the factory and protected with an outer aluminum jacket. This eliminates the time needed to insulate on the job site and prevents damage to the insulation during installation. Simply remove from the box and install.

Insul-liner® Kit Includes:

Insulated Aluminum Liner
Chimney Flashing
Rain Cap
Mortar Collar
3 Screws
Part No.: 2GIAKXX
Dia.: ____ | Lgth.: ____
Dia.: 3", 4", 5", 6", 7", 8"
Lengths: 15'



Insul-liner® Gas Fireplace Kit Includes:

Insulated Aluminum Liner
Chimney Flashing
Rain Cap
Fireplace Connector
3 Screws
Part No.: 2GIAFKX
Dia.: ____ | Lgth.: ____
Dia.: 4", 5", 6" Lengths: 15'



Fireplace Connector

Gas Fireplace Kits only.
Part No.: 2ZSCPRP
Dia.: ____
Dia.: 3", 4", 5", 6", 7", 8"



Nose Cone

Part No.: 2NCXXXX
Dia.: ____
Dia.: 3", 4", 5", 6", 7", 8", 10"



Galvanized Y

Part No.: 2GAYXXX
Dia.: ____ | Lgth.: ____
Dia.: 3", 4", 5", 6", 7", 8"



Connects two vent connectors to common vent.

Liner Coupling

Part No.: 2CNNTRG
Dia.: ____
Dia.: 3", 4", 5", 6", 7", 8", 10"
Custom sizes available. Used to attach two lengths of vent.



Universal B-Vent Connector

Part No.: 2CNNBFC
Dia.: ____
Dia.: 3", 4", 5", 6", 7", 8", 10"
Connects any B-Vent to Z-FLEX® liner.



Additional Length Aluminum 2-Ply Liner

Part No.: 2GAXXXX
Dia.: ____ | Lgth.: ____
Dia.: 3", 4", 5", 6", 7", 8", 10"
Available in multiples of 5' to 50'.



Z-FLEX[®] Features and Benefits

Z-Flex[®] Triple Lock[®] - Manufactured from 316Ti, titanium stabilized, nickel, chromium, molybdenum stainless steel. Excellent resistance to the corrosive effects of flue gases. Suitable for extended periods at elevated temperatures without compromising corrosion resistance. A superior 29-4C grade stainless steel option is also available for conditions requiring greater resistance to acidic attack.

Construction - Triple Lock[®] Joint System; acknowledged to be the best available for strength and longevity. Stainless steel strip is spirally wound and mechanically joined together forming an air tight and leak-proof **Triple Lock[®]** seam. The corrugated outer wall provides crush protection during installation. The thin walled corrugated construction conducts heat quickly, aiding draft and discouraging the buildup of soot and other potentially corrosive residue.

Dimensions - Available in a range of sizes suiting all applications, from 2" to 24" diameter. Supplied in standard lengths up to 50 ft.

Triple Lock[®] Smoothcore Construction - Twin Strip (2 ply) construction. The corrugated outer wall provides crush resistance during installation. The inner wall is smooth, permitting the smooth flow of flue gases and impeding the build up of soot and other potentially corrosive residue. The inner and outer walls are joined by a **Triple Lock[®] Joint System**; acknowledged to be the best available for strength and longevity.

Approval - Z-Flex[®] Triple Lock[®] Chimney Liner Systems are listed and labelled by Underwriters Laboratories to UL1777 and ULC S635, Chimney Lining Systems for existing Masonry and Factory Built Chimneys.

Warranty - Lifetime Limited Warranty.

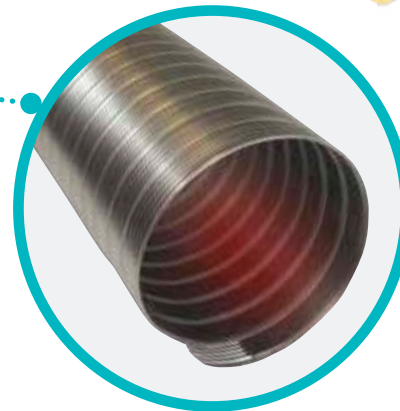
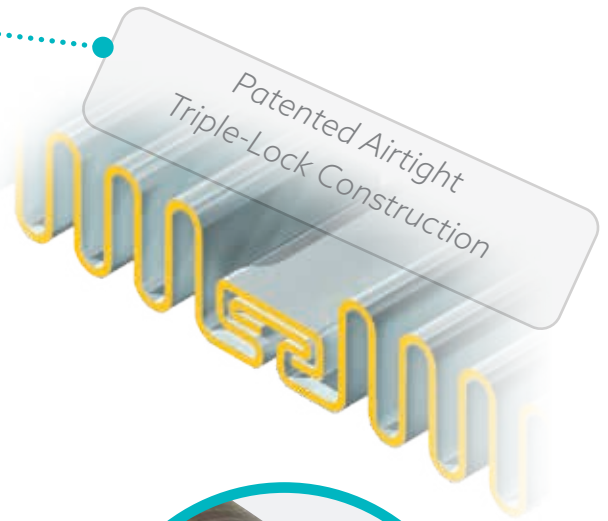

When to Z-FLEX[®] a Chimney

- When a masonry chimney has no liner at all
- When damage to existing chimney lining is evident
- When retrofit appliance has fan-assisted combustion and is vented alone
- When additional or replacement equipment is installed or an appliance is converted to gas from another fuel
- When the existing chimney is oversized relative to heating requirement

Z-FLEX[®] Chimney Liner Systems

Smoothcore Triple Lock[®] Liner eliminates turbulence inherent with corrugated liners, improving draft. Resists corrosive attack by not impeding the flow of condensate down the liner. Less opportunity for soot to accumulate.



Z-Max Rain Cap and Top Support Flashing

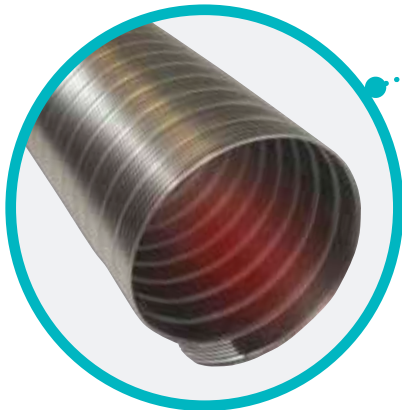

Triple Lock[®] Liner



Z-Lok[®] Tee

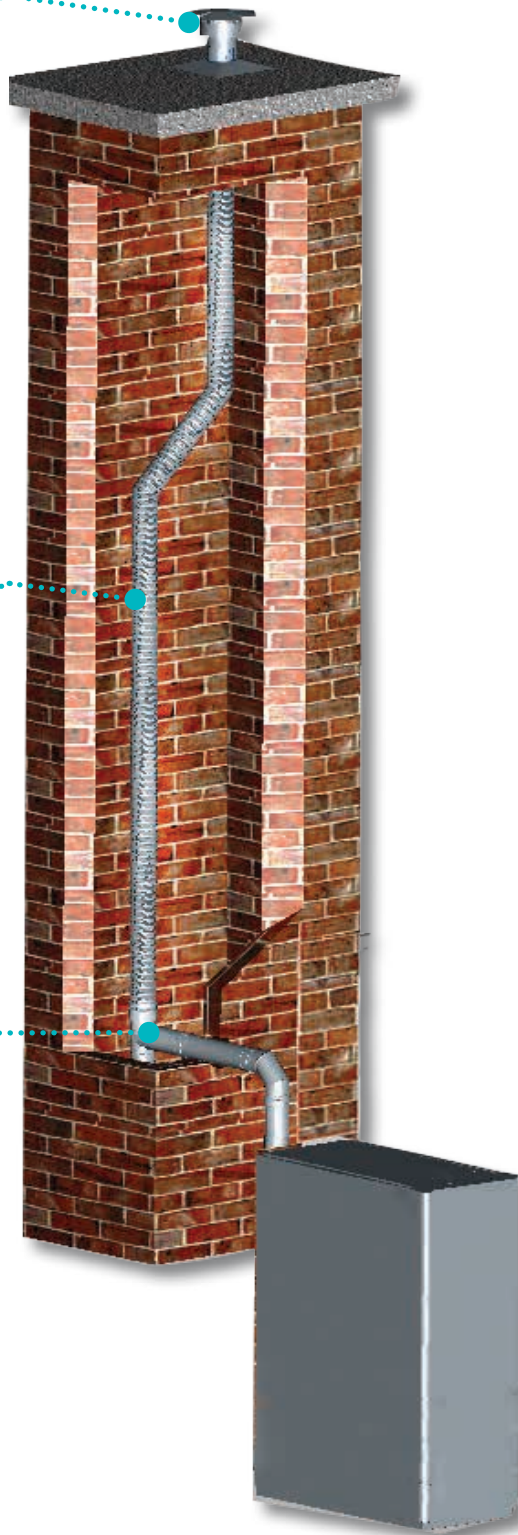

Z-FLEX® Stainless Steel Chimney Kits

Everything you need to get the job done right

Triple Lock® Stainless Steel ALL FUEL APPLICATIONS

- **Z-FLEX®** Stainless Steel Chimney Liner Kits come complete with everything you need to quickly and easily install a professional venting system.

- **Patented Airtight Triple Lock® Construction**

Ideal for use with gas, oil, pellets and wood. (For use with coal, see warranty). The patented Triple Lock® construction is tested and listed by U.L. Triple Lock® is accepted by industry as the strongest joint system available.

- Manufactured from special high temperature and acid 316Ti resistant stainless.

- **Z-FLEX®**'s specially designed corrugations provide excellent flexibility while maintaining superior crush strength. The result is a clearly superior product offering incredible longevity.

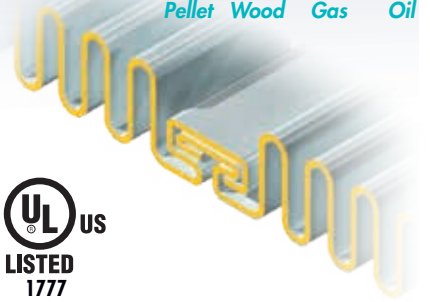

Oil & Gas Kit Includes:

Stainless Steel Liner
Chimney Flashing
Rain Cap
Mortar Collar
Part No.: 2OILKITX
Dia.: ____ | Lgth.: ____
Dia.: 3"-24" | Lengths: 50'



All Fuel Kit Includes:

Stainless Steel Liner
Chimney Flashing
Rain Cap
Z-Lok Tee
Part No.: 2ZFLKIT
Dia.: ____ | Lgth.: ____
Dia.: 3"-24" | Lengths: 50'



Pellet Kit Includes:

Stainless Steel Liner
Chimney Flashing
Rain Cap
Pellet Tee
Part No.: 2ZFLKIT_ _ _ _P
Dia.: ____ | Lgth.: ____
Dia.: 3"-4" | Lengths: 50'



All Fuel Insert Kit Includes:

Stainless Steel Liner
Chimney Flashing
Rain Cap
Stove Adaptor
Part No.: 2OILKITX_I
Dia.: ____ | Lgth.: ____
Dia.: 3"-24" | Lengths: 50'



Smoothcore Kit Includes:

Smoothcore Stainless Steel Liner
Chimney Flashing
Rain Cap
Z-Lok Tee
Part No.: 2ZFSCKIT
Dia.: ____ | Lgth.: ____
Dia.: 5"-8" | Lengths: 50'



Universal All Fuel Kit Includes:

Stainless Steel Liner
Chimney Flashing
Rain Cap
Dripless Connector
Rigid Stacking Tee
Part No.: 2ZFLKTO
Dia.: ____ | Lgth.: ____
Dia.: 3"-24" | Lengths: 50'



Z-FLEX® Chimney Liner Systems

Triple Lock® Stainless Steel Flex Liner & Accessories ALL FUEL APPLICATIONS

2" Fresh Air Kit for Pellet Stoves

Kit includes:
1 - 2" x 5' Aluminum 1 ply duct
1 - 2" intake hood w/screen
2 - 2" gear clamps
Part No.: 2FAKIT0205



4" Fresh Air Kit for Pellet Stoves

Kit includes:
1 - 4" x 5' Aluminum 1 ply duct
1 - 4" intake hood w/screen
2 - 4" gear clamps
Part No.: 2FAKIT0405



Triple Lock® Stainless Steel Flex Liner

Part No.: 2ZLSSXX
Dia.: ____ | Lgth.: ____
Part No.: 2ZL294C
Dia.: ____ | Lgth.: ____
Dia.: 2" - 24"
Lengths: Up to 50' or multiples of 5'.



Triple Lock® Smoothcore Flex Liner

Part No.: 2ZLSCXX
Dia.: ____ | Lgth.: ____
Dia.: 5" - 8"
Lengths: 5' to 20 ft.

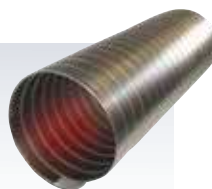

Heavy Wall Flex Liner

Part No.: 2ZLMHLXX
Dia.: ____
Lgth.: ____
Dia.: 3" - 8"
Lengths: Up to 50' or multiples of 5'.

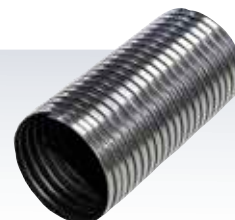

Lock N'Go Tee

Part No.: 2ZFTCB
Dia.: ____
Dia.: 3" - 24"
Flex Ready Tee with Gear
Clamp Assembly



Z-Lok Tee

Part No.: 2ZFTJ
Dia.: ____
Dia.: 3" - 8"
Flex ready tool-less
connection.



4" Flex Ready Pellet Tee with 3" Branch

Part No.: 2ZPT43
Connects Z-Flex to solid fuel
inserts where space is minimal.



Offset Adaptor 30°

Part No.: 2ZOA30
Dia.: ____
Dia.: 3" - 10"



Offset Adaptor 45°

Part No.: 2ZOA45
Dia.: ____
Dia.: 3" - 10"



Apply the right liner every time with Line Finder from Z-FLEX®. Gas and Oil Liner Finders make it fast and easy to match the right Z-FLEX® product and size to the liner application. The convenient "slide rule" design is simple to use, portable, and foolproof.

Triple Lock® Stainless Steel Flex Liner & Accessories ALL FUEL APPLICATIONS

Z-Max® Deluxe Rain Cap & Flashing

Rain Cap: 2ZMRCS_
Flashing: 2AFCS_ with 13"x13" base
Flashing: 2AFCX_ with 18"x18" base
Dia.: ____
Dia.: 3" – 10"

ZMax® Rain Cap prevents moisture and debris entering the chimney. Pre-stressed base plate provides greater strength under snow load conditions. For use with flexible liner.
Spark arrester meets California code.



Extension for Z-Max® Raincap

Part No.: 2ZMEXT0_
Dia.: 4" – 8"
18" extension



Dripless Type "C" Connector

Part No.: 2CNNTRC
Dia.: ____
Dia.: 3" – 24"
Used to connect Z-FLEX® Liner to stove-pipe, fireplace insert or other liner component.



Insert Connector

Part No.: 2CNNI
Dia.: ____
Dia.: 4" – 10"
Used to connect flexible liner to insert. Supplied with three tabs for ease connection to insert from inside firebox.
*6" insert to 5" liner reducer available.



Insulating Blanket w/Protective Cloth Wrap & Gear Clamps

Part No.: 2INSKIT
Dia.: ____
Sold in 5, 10, 25 ft kits.
1, 2, 3, 4 ft lengths. Includes 2 gear clamps per 5' section. 1/4", 8lb. ceramic fiber insulation with high temperature protective cloth wrap. Resists damage during installation.



Nose Cone

Part No.: 2NCXXX
Dia.: ____
Dia.: 3" – 24"
To attach to liner, attach rope to cone and pull rope down chimney.



Stainless Steel Offset Box

Part No.: 2ZFOFFSET
6" only
Used to connect flex liner to insert. One piece design. 6" center to center offset.



Z-FLEX® Chimney Liner Systems

Rigid Liner & Accessories ALL FUEL APPLICATIONS

Stainless Steel Rigid Liner

Part No.: 2ZR321F
Dia.: _____ Lgth.: _____
Dia.: 3" - 24"
Fusions welded seams.
Close tolerance fit.
1ft, 2ft, 3ft, 4ft lengths.



Rigid Stacking Tee

Part No.: 2ZRBXXX

Dia.: _____
Dia.: 3"-24"

Tees have removable clean-out caps and removable long nose spout.
NOTE: 3" and 10"-24" nose spouts are not removable.



Rain Cap

Part No.: 2RNCAPS

Dia.: _____
Dia.: 3" - 24"

For use with rigid liner
Spark arrester meets California code



90° Adjustable Elbow

Part No.: 2RE90XX

Dia.: _____
Dia.: 3" - 24"



45° Adjustable Elbow

Part No.: 2RE45XX

Dia.: _____ | Lgth.: _____
Dia.: 3" - 24"



Reducer

Reducer Part No:

2RD____ R____ X____

Available in 4"-3", 5"-4", 6"-5", 7"-6", 8"-6", 8"-7", 10"-8. Used to reduce the liner size to accommodate a range of flue sizes, appliances and installations.

Note flow direction.



Stainless Steel Chimney Flashing Starter Collar 16" x 16" Base

Part No.: 2ZSCSXX

Dia.: _____

Dia.: 3" - 24"

Used to cover chimney top opening.

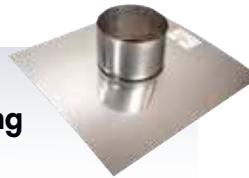

Top Support

Part No.: 2ZTSXXX

Dia.: _____
Dia.: 3" - 24"

For use with flex liner and flashing.



Increaser

Increaser Part No.

2IN____ R____ X____

Available diameters 3"-4", 4"-5", 5"-6", 6"-7", 6"-8", 7"-8", 8"-10".

Used to increase the liner size to accommodate a range of flue sizes, appliances and installations. **Note flow direction.**

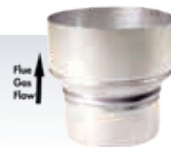

Base Tee Adapter

Part No.: 2ZRBTA

Dia.: _____

Dia.: 4" - 8"

Adapts base tee branch to stove pipe. Large end/Large end.



Stainless Steel Self-Drilling Screws

Part No.: 2SSSCREW



Aerocowl Flue Stabilizer



Aerocowl Flue Stabilizer is aerodynamically designed so that when fitted to structurally sound chimneys and flues, completely eliminates down-draft. **Aerocowl** prevents troublesome smoke and toxic fumes from circulating within the home.

Aerocowl built-in bleeding system reduces excessive fuel burning for all types of heating appliances whether solid fuel, oil, gas or wood-burning, resulting in significant savings in energy consumption.

Aerocowl Universal Base

Part No.: 2ARCOUB



Stainless Steel Aerocowl Round Base

Part No.: 2ARCORB

Dia.: _____
Dia.: 4", 5", 6", 7", 8", 10"



Stainless Steel Aerocowl

Part No.: 2ARCOWL_B

Dia.: 12", 18"



Saves Fuel - Saves Money

After fitting an Aerocowl, testing found a minimum saving of 12% and in some cases up to 30%.

Easily Installed

Simple installation. Just locate on to chimney, and secure. Available in three sizes to fit all domestic chimneys and flues.

Doubles as a Rain Cap

Prevents rain, snow or sleet entering the chimney or flue.

Reduces Condensation

Aerocowl improves ventilation and reduces condensation.

Aesthetic Design

Aerodynamic design; blends in naturally with surroundings.

Long Service Life

Comprehensive Accelerated Corrosion Testing rates an average life expectancy of 12 years.

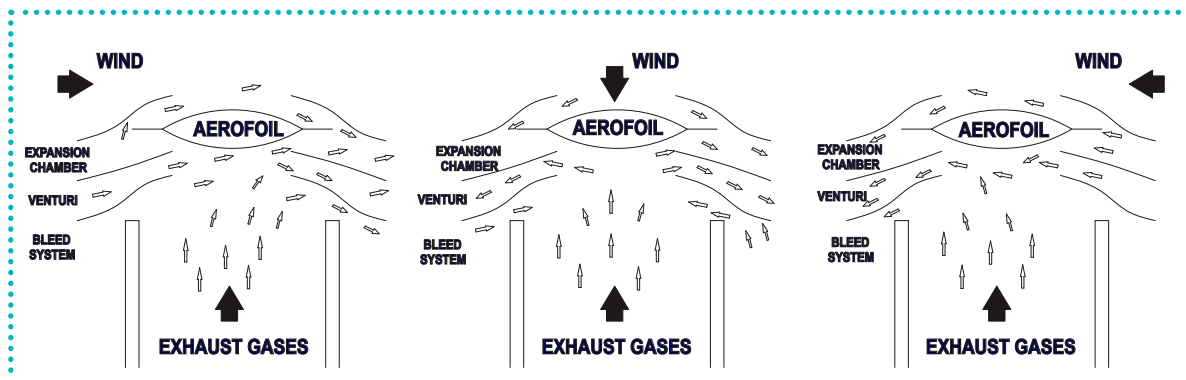

Z-FLEX® Chimney Liner Systems

Oval Liner System All Fuel Applications

Flexible S/S Full Oval

Part No.: 2ZLSSOX

Dia.: ____ | Lgth.: ____

Dia.: 6", 7", 8", 10"

Note: Oval accessories available.



Z-Flex® Stainless Steel Liner Oval Dimensions (Approximate)

Round Size	Oval Size	O.D.
5"	4 1/4" x 7 3/4"	
6"	4 1/2" x 8 3/8"	
7"	4 3/4" x 9 1/2"	
8"	5" x 11"	



Flexible S/S Oval To Round

Part No.: 2ZLSSOR

Dia.: ____ | Lgth.: ____

Dia.: 6", 7", 8", 10"

5 ft to 10 ft available. Oval accessories available



Stainless Steel Dripless Type "A" Oval Connector

Part No.: 2CNNTRA

OV: ____ | Dia.: ____

Dia.: 6", 7", 8", 10"

Used to join Z-FLEX® Oval Liner to Oval T-Section and Oval to Oval Liner or when going through a fireplace adapter.



Stainless Steel Single Oval Base/Tee with Removable Round Branch

Part No.: 2ZRBTOX

Dia.: ____

Dia.: 6", 7", 8", 10"



Oval To Round Adapter

Part No.: 2ZRORAX

Dia.: ____

Dia.: 6", 7", 8", 10"



Round to Oval Adapter

Part No.: 2ZRROAX

Dia.: ____

Dia.: 6", 7", 8", 10"



Flat Flashing Oval 6"

Part No.: (2ZSCO1806)

18 X 18

Dia.: ____

Dia.: 6", 7", 8", 10"

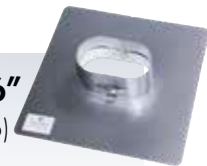

Oval Raincap with Spark Arrestor

Part No.: (2ZMRCOV_ _)

Dia.: ____

Dia.: 6", 7", 8", 10"



DIRECT VENT System

A Completely Sealed System that does not Compromise Indoor Air Quality Designed for use when converting existing wood-burning fireplaces into gas fireplaces

In terms of safety, efficiency and versatility, Direct Vent fireplaces have several advantages over traditional fireplaces.

Using indoor air for combustion can de-pressurize the living space and potentially pull harmful flue gases back into the home. Direct Vent Systems use outdoor air instead of indoor air for combustion. Outside air is drawn in for combustion while flue gas is exhausted outside. The natural flow of heat creates a convection loop; as hot air exits the pipe, cooler, denser air is pulled back to the burner.

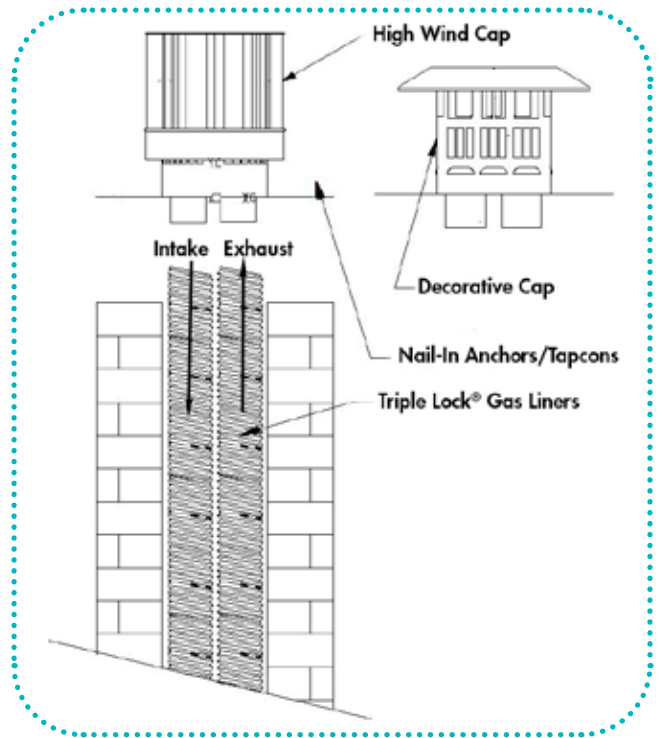

Direct Vent Insert Kits include: Two Triple Lock[®] Gas Liners for flue exhaust and outside combustion air, and either an extreme weather or decorative co-linear termination.

Decorative Kit



Direct Vent Co-Linear Flexible Liner Kit with *Decorative Cap/Flashing*

includes:

- Chimney Liners (Exhaust and Intake)
- Decorative Cap/Flashing
- High Temperature RTV Sealant
- Self-Tapping Screws

Extreme Weather Kit



Direct Vent Co-Linear Flexible Liner Kit with *Extreme Weather Cap/Flashing*

includes:

- Chimney Liners (Exhaust and Intake)
- Extreme Weather Cap/Flashing
- High Temperature RTV Sealant
- Self-tapping Screws

Z-FLEX® Chimney Liner Systems

DIRECT VENT System

Safety - Direct Vent Systems exhaust all products of combustion outside maintaining higher indoor air quality. When fuel burns, releasing poisonous carbon monoxide becoming dangerous when exposed to it for too long and in high concentrations. Direct Vent flue Systems are completely sealed from the interior of the building, therefore no harmful flue gases are released into the living space.

Efficiency - Direct Vent Fireplace Systems burn natural gas or propane, unlike tradition fireplaces, converting most of the fuel to usable heat. They are completely sealed off from the interior rooms by a glass door, which prevents significant heat loss.

Quality - Z-Flex Triple Lock®, regarded as the strongest flexible duct construction method in the industry; provides piece of mind that flue gases are being safely vented outside the living space through continuous length flexible gas vent. In addition, computer added design and construction methods help produce aesthetically pleasing and efficient system components.

Versatility - Direct Vent Systems are easy to install. Continuous length Triple Lock® Flexible Gas Vent provides only two connection points; Insert and Termination. The Flexible Venting is quickly and easily routed through straight or offset existing masonry chimneys. Extreme Weather and Decorative Terminations are available for any installation.

Z-Flex Direct Vent Systems

Part ID	Description	Exhaust size	Intake size
2DVI335D	DV Co-Linear 3/3 Decorative Kit X 35 Ft	3 in.	3 in.
2DVI335X	DV Co-Linear 3/3 Extreme Weather Kit X 35 Ft	3 in.	3 in.
2DVI435D	DV Co-Linear 4/3 Decorative Kit X 35 Ft	4 in.	3 in.
2DVI435X	DV Co-Linear 4/3 Extreme Weather Kit X 35 Ft	4 in.	3 in.

Safety Issues

Since the federal government required modern heating equipment to achieve higher efficiencies in 1992, safely venting them has become more of a challenge. Today's more efficient equipment produces lower flue gas temperatures than pre-1992 equipment. The low temperature flue gas provides little natural draft in chimneys and is more likely to condense into an acidic, and corrosive, solution. The result can cause property damage, personal injury, or death. The natural laws of physics that control this phenomenon pertain to all gas and oil fired equipment.

Our three major product lines; chimney liners, special gas vent (AL29-4C®* stainless steel), and flexible vent connectors are all designed to prevent flue gas condensation or protect against its corrosive effects. Most of the products **Z-FLEX®**

has developed are now recommended or required by the following national codes and testing agencies:

1992 National Fuel Gas Code

Venting Tables for sizing Chimney Liners and Vent Connectors when adding or replacing equipment. Insulated Connectors required in attics and other "cold" spaces.

1997 NFPA 31

"Installation of Oil Burning Equipment" Venting Tables for sizing Chimney Liners.

International Approval Services (Formerly AGA) June, 1996

– IAS requires all Category III gas boilers and furnaces to use a UL 1738 approved vent system (as **Z-VENT®**). July, 1998 – IAS requires all Category III gas residential unit heaters to use a UL 1738 approved vent system(as **Z-VENT®**).

Coaxial *FLEXIBLE* Direct Vent Kits

- Z-Flex[®] DVK Kits are designed to ease gas burning fireplace or insert installations
- Allows for a completely sealed system that does not compromise indoor air quality
- Kit includes two TRIPLE LOCK[®] flexible vents, one for flue exhaust, the other for combustion air
- Available in coaxial vertical extreme weather, horizontal round or square termination options

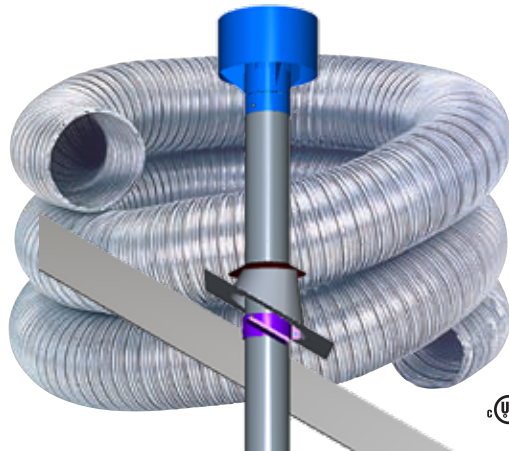

Vertical

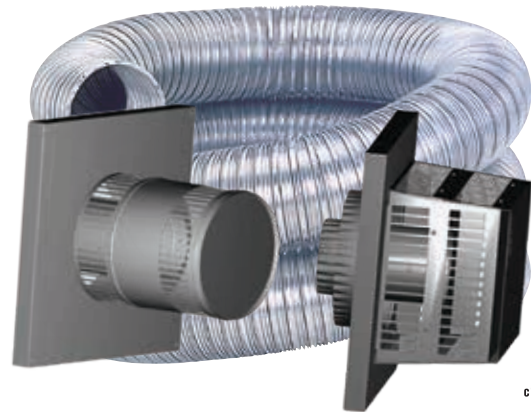

Horizontal

UL US
2112
ANSI Z21.88
CSA 2.33

Model DVK-VX
Coaxial Flexible Direct Vent Kit with Vertical Extreme Weather Termination

Kit also includes:

Coaxial Flexible Vent
Spacers & Supports
Fire Stop/Insulation Shield
Insulation Collar
Rigid Pipe with Roof Support
Flashing for 0° to 30° Pitched Roof
Storm Collar/Support
High Temperature Sealant
Self-Drilling Screws

Model DVK-HR
Coaxial Flexible Direct Vent Kit with Horizontal *ROUND* Termination

Kit also includes:

Coaxial Flexible Vent
Spacers & Supports
High Temperature Sealant
Self-Drilling Screws

Model DVK-HT
Coaxial Flexible Direct Vent Kit with Horizontal *SQUARE* Termination

Kit also includes:

Coaxial Flexible Vent
Spacers & Supports
High Temperature Sealant
Self-Drilling Screws

Z-Flex Coaxial *FLEXIBLE* Direct Vent Kits

Part ID	Description
2DVK(305,306,406,407,4.507.5,507,508,608,710,811)(05,10,20,40)VX	Direct Vent Kit Vertical Extreme Weather Termination
2DVK(305,306,406,407,4.507.5,507,508,608,710,811)(05,10,20,40)HR	Direct Vent Kit Horizontal <i>ROUND</i> Termination
2DVK(305,306,406,407,4.507.5,507,508,608,710,811)(05,10,20,40)HT	Direct Vent Horizontal <i>SQUARE</i> Termination

*Select appropriate coaxial vent diameters in inches; (305,306,406,407,4.507.5, 507, 508, 608, 710, 811) and length in feet; (05,10,20,40) when ordering, additional lengths available upon request

Z-FLEX® Chimney Liner Systems

Coaxial FLEXIBLE Direct Vent Kits

DVK Kits

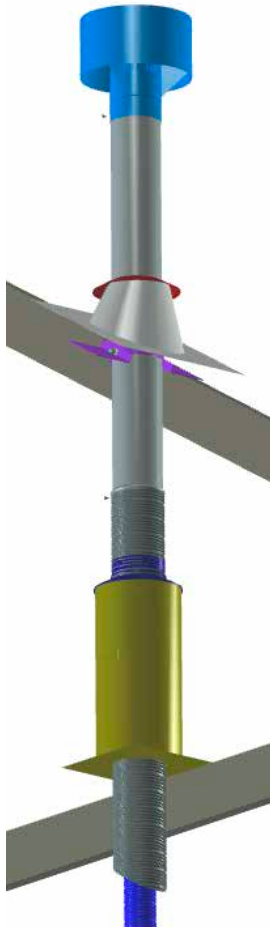

Typical Vertical Installation: 2DVK-VX



Typical Horizontal Installation: 2DVK-HR

Accessory Kits

Coaxial Flexible Extension Kit

Part No's 2DVK (305, 306, 406, 407, 4.507.5, 507,508, 608, 710, 811) 20X
Coaxial Flexible Coupling
20 Ft. Coaxial Flexible Vent
Spacers & Supports
Sealant & Self-drilling Screws

Coaxial Flexible Coupling Kit

Part No's 2DVK (305, 306, 406, 407, 4.507.5, 507, 508, 608, 710, 811)C
Coaxial Flexible Coupling
Sealant & Self-drilling Screws

Coaxial Flexible Spacer Kit (10/kit)

Part No's for wire spacers: 2DVK (35, 36, 46, 47, 57, 58, 68, 710, 811)S

Adaptor DV 4/6.625 to Flex 4/7 Kit Part No: 2DVK407A or

Adaptor DV 5/8 to Flex 5/8 Kit Part No 2DVK508A

Adaptor
Sealant & Self-drilling Screws

Coaxial Flexible Support Kit (5/kit)

Part No's: 2DVK (05, 06, 07, 07.5, 08, 10, 11)SUP

Wall Thimble (for 4" to 7" thick walls)

Part No's: 2DVK (05, 06, 07, 07.5, 08, 10, 11)WT

Wall Thimble Extended (for 6" to 11" thick walls)

Part No's: 2DVK (05, 06, 07, 07.5, 08, 10, 11)WTE

Siding Standoff

Part No's: 2DVK (05, 06, 07, 07.5, 08, 10, 11)SS

Fire Stop Part No's: 2DVK (05, 06, 07, 07.5, 08, 10, 11)FS

Fire stop sealant is field supplied

Fire Stop/Insulation Shield & Insulation Collar Kit

Part No's: 2DVK (05, 06, 07, 07.5, 08, 10, 11)FSIS

Fire stop sealant is field supplied

Flashing 30 to 45 Degree Pitched Roofs

Part No's: 2DVK (05, 06, 07, 07.5, 08, 10, 11)F

Rigid Extension Pipe Kit

Part No's: 2DVKRE (35, 36, 46, 47, 4.57.5, 58, 68, 710, 811)

30" Long Rigid Exterior & Flexible Inner Pipe with Male Connector

Guy Band

Sealant & Self-Drilling Screws

Sealant Part No: 2DVKS

Z-FLEX®

The Flexible Venting Solutions Specialist

Z-FLEX®, part of the Novaflex Group of companies, is the leading manufacturer of specialty venting systems for furnaces, boilers, water heaters, oil heaters, fireplaces, and more.

Z-FLEX® has been providing flexible answers to gas oil, pellet and wood venting applications since 1979. We have pioneered flexible chimney liner solutions and special gas vent (AL 29-4C®).* A variety of innovations in materials and construction have led to products that deliver:

- Superior performance and increased efficiency
- Easier handling and faster, simpler installation
- Greater reliability, safety and increased service life

To that, we add responsive customer service and expert technical support.

The NovaFlex Group® is a privately held company committed to continuous advancement in venting, HVAC, hose and connector solutions. NovaFlex® has one of the broadest product ranges available in the hose and ducting marketplace as well as in the HVAC, Industrial Venting and Hose Industries and in Commercial Exhaust Venting Systems.

The information provided within is for informational purposes only. We have made every effort to ensure the accuracy of the provided information and assume no responsibility for any loss or damage due to errors or omissions or to the use or misuse of any information supplied. It is impossible to test all products under all conditions to which they might be subjected in the field. It is therefore the buyer and/or end users' responsibility to test all products under the conditions that duplicate the service conditions prior to installation. All improvements, all specifications are subject to change without prior notice. It is the buyer and/or end users' responsibility to review our complete **Terms and Conditions of Sale** located on our web sites at: www.novaflex.com | www.z-flex.com | www.flexmaster.com.

*AL 29-4C® is a registered trademark of Allegheny Ludlum Corp.



U.S.A.
20 Commerce Park North
Bedford, New Hampshire 03110-6911
tel: 603.669.5136 fax: 888.889.3539

CANADA
452 Attwell Drive
Etobicoke, ON M9W 5C3
tel: 416.679.0045 fax: 416.679.0051